

English

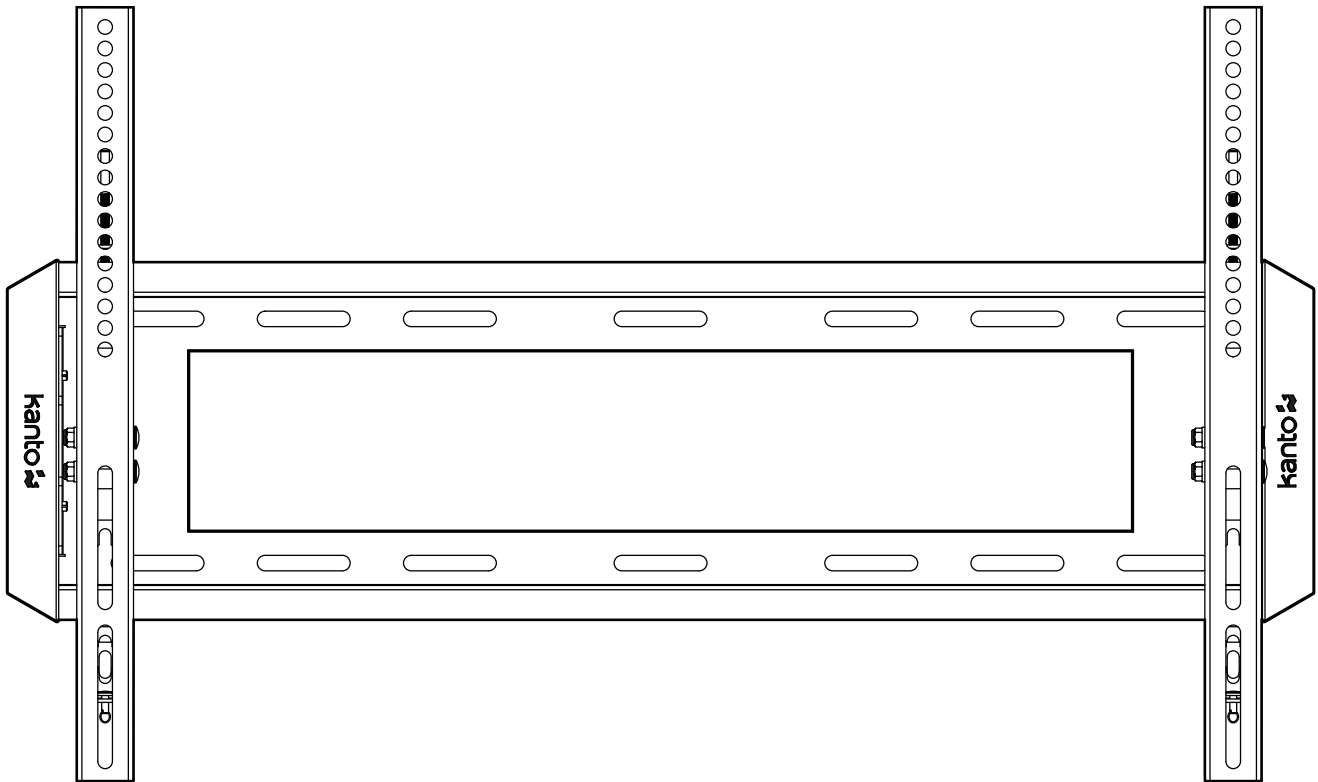

User Manual

T3760 TV Mount



TILTING FLAT PANEL TV MOUNT

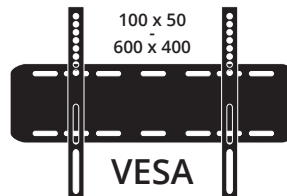
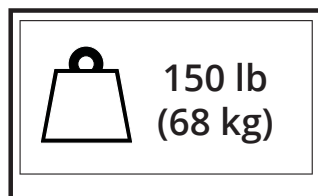

+10°/-5°



Table of Contents

Table of Contents / Introduction	2	Setup - Steps 3 and 4.	6
Supplied Parts & Hardware	3	Setup - Steps 5 and 6.	7
Setup - Step 1	4	Other Kanto Products	8
Setup - Step 2	5	Warranty	8

Introduction

Thank you for choosing a Kanto AV Systems tilting wall mount. The T3760 is designed to mount flat panel televisions weighing up to 150 lbs (68 kg) within less than 2" of your wall. This mount will tilt your TV +10° / -5°.

Read these instructions fully before installation of this mount. If you do not understand these directions, or have any doubts about the safety of the installation, please consult a qualified installation contractor to install this mount. Make sure there are no defective or missing parts. Do not use defective parts. If you are uncertain whether the part is defective call Kanto AV Systems directly at 1-888-848-2643 or support@kantoav.com. Kanto AV Systems can not be liable for property damage or injury caused by incorrect mounting, incorrect assembly, lifting or incorrect use of this product.

This product should not be mounted on steel stud walls or cinder block walls. Consult a qualified installation contractor if you are unsure about the type of wall you may have. We make every effort to ensure all necessary hardware is included. If there is hardware missing please call Kanto AV Systems directly at 1-888-848-2643 or support@kantoav.com.



See installation video online at:
www.kantoliving.com



CAUTION

The maximum loading weight is 150 lbs (68 kg). This wall mount is intended for use only within the maximum weight restrictions indicated. Use with products heavier than the maximum weights indicated may result in instability causing possible injury. Recommended TV Size: 37 inch to 70 inch.



CAUTION

The wall you plan to affix the Kanto mount to must be able to support more than 5 times the weight of the television and the wall mount combined. Do not use this product for any purpose other than to mount a flat panel TV on a vertical surface as outlined in this manual. Improper installation may cause damage to your TV or serious injury. This product should not be mounted to steel stud walls, cinder block or old concrete walls. Consult a qualified installation contractor if you are unsure about the type of wall you may have.

Supplied Parts and Hardware

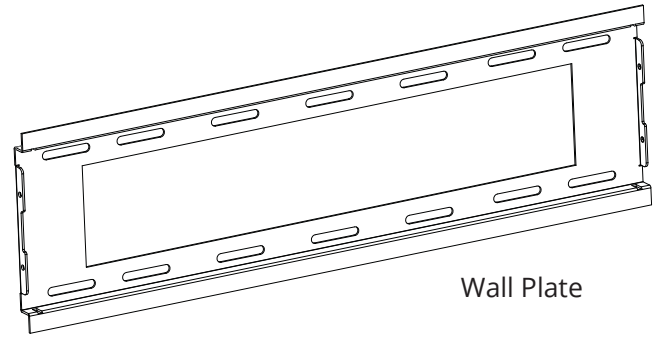

Wall Plate



x4

A: M5 x 15mm Bolt

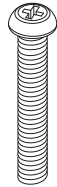

x4

B: M5 x 25mm Bolt

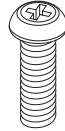

x4

C: M6 x 15mm Bolt

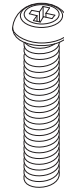

x4

D: M6 x 25mm Bolt

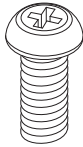

x4

E: M8 x 20mm Bolt

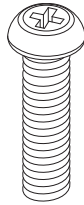

x4

F: M8 x 35mm Bolt

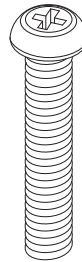

x4

G: M8 x 50mm Bolt

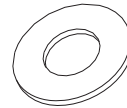

x4

H: Washer

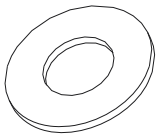

x4

I: Lag Bolt Washer

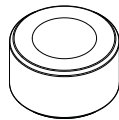

x4

J: 5mm



x4

K: 10mm

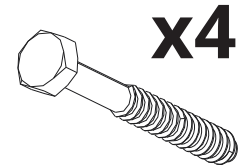

x4

L: Lag Bolt

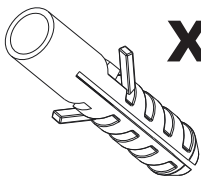

x4

M: Concrete Anchor



x2

N: M5 x 10mm Bolt

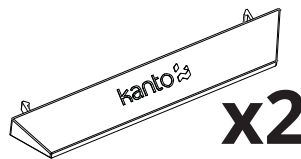

x2

O: Plastic Cap

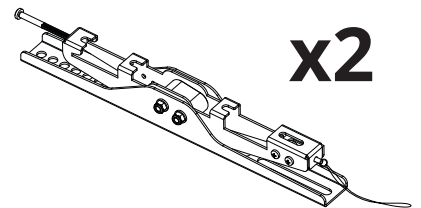

x2

P: Quick-Lock TV Bracket

Required Tools

- 3/16" Wood drill bit
- 7/16" Masonry bit (for concrete installs)
- Socket set
- Phillips screwdriver
- Hammer (for concrete installs)
- Carpenter's level
- Stud finder

Step 1: Attach TV Brackets

There are a wide variety of TVs available offering an assortment of bolt sizes. We provide a selection of mounting bolts to fit most TVs. If you have any concerns about this mounting hardware or installation call us direct at 1-888-848-2643 or email at support@kantoav.com.

Step 1.1 Select the correct size of bolt.

Kanto provides 3 bolt diameters (Metric sizes M5, M6 and M8) in various lengths.

Part items: **A, B, C, D, E, F** or **G**.

Select the correct diameter bolt and hand screw into the back of the TV to determine the correct length.

Use the washer (**H**) for bolts **A-D** (sizes M5 and M6).

The washer will work for both bolt sizes. The washer is not required for M8 size bolts (**E, F & G**). If your TV has a curved back or the mounting holes are recessed, you can use the spacers (**J, K**).

Step 1.2 Attach TV bracket arms to the back of the TV

Now that you have selected the correct bolt length and spacers if necessary, it's time to attach the arms (**P**) to the TV, as shown in Diagram A.

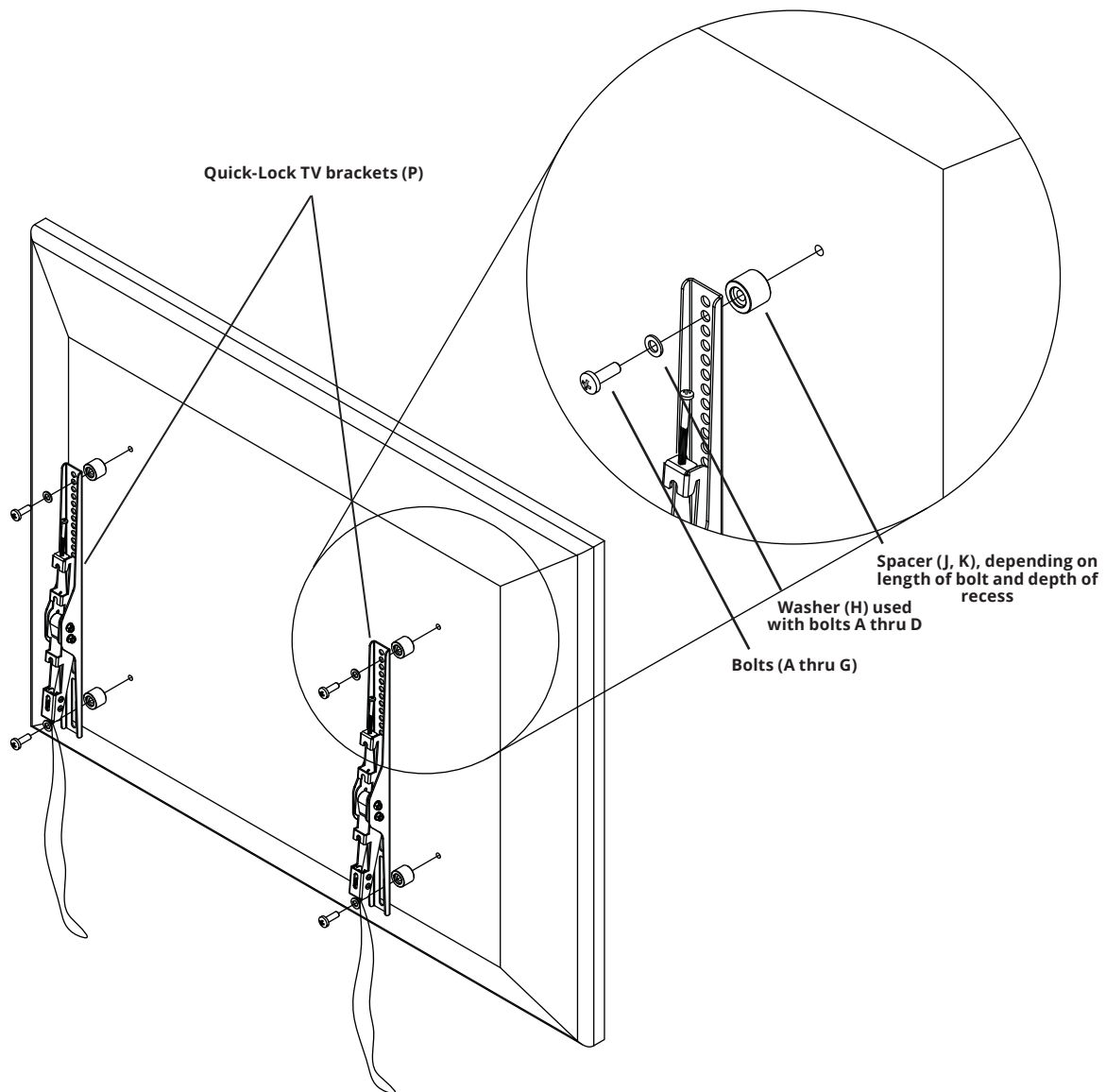

Diagram A



WARNING

Never over-tighten a bolt into the back of your flat panel TV. Do not lay the TV face down on its glass front. Use a wall or a TV stand.

Step 2: Mount Wall Plate

Attach the two plastic end caps (**O**) to the Wall Plate.

Wood Stud Wall

The Wall Plate must be mounted to two wood studs. Use a stud sensor to locate the two studs, clearly marking the outer edges of the studs (see Diagram B). Use a long level to ensure the two holes are level at the desired height.

Pre-drill two upper holes in the center of your studs, and attach the Wall Plate to the wall using 2 Lag Bolts (**L**) and Lag Bolt Washers (**I**) (see Diagram B). Do not over-tighten lag bolts (**L**). Make sure the Wall Plate is flat against the wall surface. Using the Wall Plate as template, pre-drill the bottom 2 holes, and secure using 2 Lag Bolts (**L**) and 2 Lag Bolt Washers (**I**), taking care not to over-tighten.

Brick or Concrete Wall

Using the Wall Plate as a template, mark four holes toward the outer edge of the Wall Plate at your desired height (see Diagram C). Adjust the Wall Plate position to be clear of mortar joints, keeping in mind that the mount provides minor horizontal shift along the length of the Wall Plate. Use a long level to ensure the four holes are level and at the desired height.

Pre-drill four holes, and insert a Concrete Anchor (**M**) into each of the holes flush with the concrete wall surface and not flush with the surface covering, such as drywall.

Attach the Wall Plate using 4 Lag Bolts (**L**) and Lag Bolt Washers (**I**) (see Diagram C). Make sure the Wall Plate is flat against the wall surface. Do not over-tighten Lag Bolts (**L**).

Wood

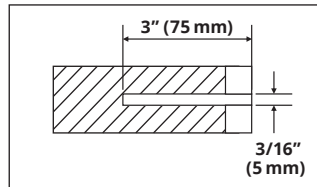

Concrete

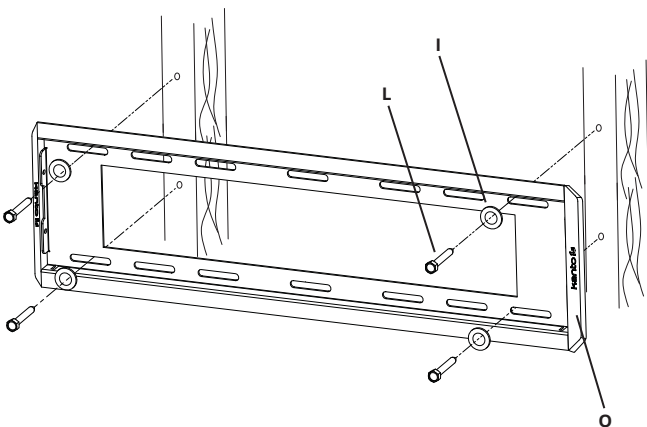
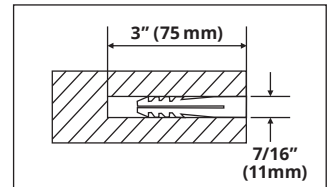

Diagram B

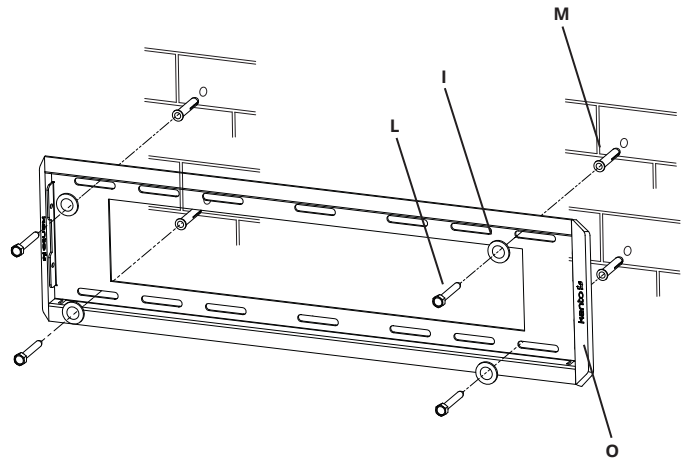

Diagram C



CAUTION

Make sure the supporting surface will support the load limits outlined in the Caution at bottom of page two. Tighten Lag Bolts until the Wall Plate is snug flat against the wall. Do not over tighten Lag Bolts (**L**). Each Lag Bolt must be located in the center of a wood stud.



CAUTION

Make sure the concrete or brick wall is at least 3.5" thick. Make sure the anchor is seated completely flush with the concrete surface even if there is another layer of material, such as drywall. If drywall is over 5/8" thick custom lag bolts must be used. Concrete must be a minimum of 2000psi in density.



CAUTION

Read this section carefully prior to install.

Step 3: Attach TV to Wall Plate

With the TV brackets firmly secured to the TV, use two people to lift the TV into position and hook the TV brackets onto the wall plate, as shown in Diagram D.

Swing the bottom of the television towards the wallplate, and the Quick-Lock bracket will lock into place.

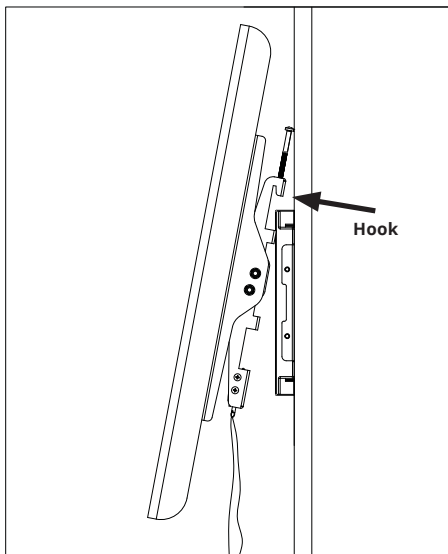

Diagram D

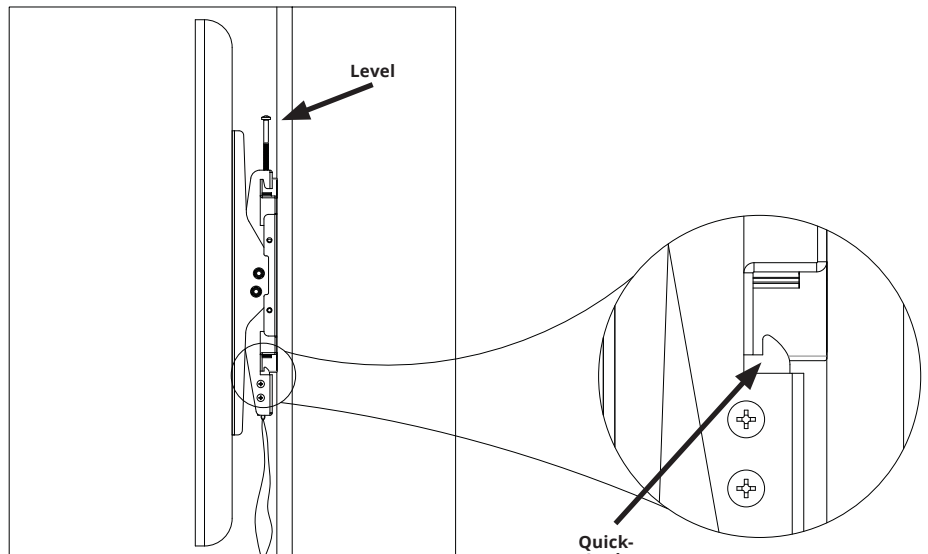

Diagram E

Step 4: Level the Television

For minor level adjustment, tighten the two top screws using a Phillips screwdriver to ensure the TV hangs level, as shown in Diagram E. You may need to pull down slightly on the Quick-Lock release cord to relieve pressure.



WARNING

Use two people to lift and position the TV onto the Wall Plate.

Step 5: Tilt the TV

Your Kanto tilting mount features a unique Magic Tilt™ system that is pre-tensioned at the factory. With your TV mounted to the wall plate, simply tilt the TV to your desired viewing angle, between +10° and -5°, and your installation is complete.

As an added feature, the T3760 can be locked into position at three tilt positions, as shown in Diagram F. Use the M5 x 10mm bolts (N) supplied to lock the tilt arm in place at either -5°, 0° or +5°. Bolt holes are on the right side of each tilt arm.

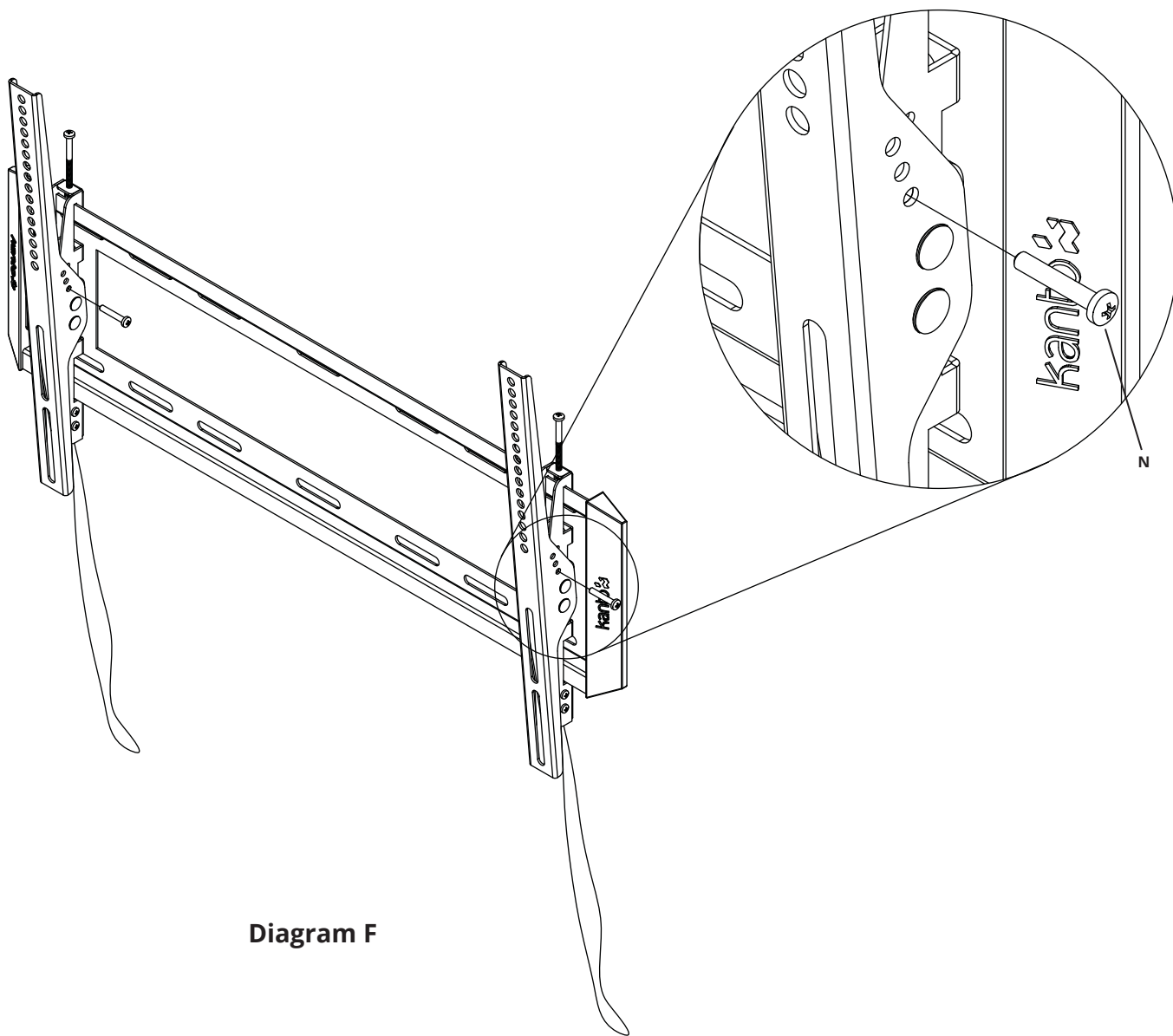

Diagram F

Step 6: Remove the TV

To remove the TV from the wallplate, pull down on the cords to release the Quick-Lock™ mechanisms. Use two people to pull the bottom of the TV away from the wall and lift it off the wallplate.



Check out more great products from Kanto!

Kanto Speakers

- Check out our full line of bookshelf and desktop speaker systems
- Available in a stunning array of colors
- Visit kantospeakers.com for more!

YU2
+
S2



sub6

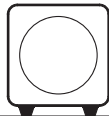

YU4

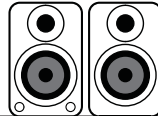

link
par kanto

- Full line of Audio and Video Cables
- White or Black Cables available
- HDMI, Optical, Mini-jack, RCA, USB
- Switchers, Hubs, and Adapters
- Visit kantoliving.com



To learn more about all our products, visit www.kantoliving.com

f Kanto Living

@kantoliving

kantoliving

Kanto Living

Kanto Living

Warranty

Limited Warranty to Original Purchaser

Kanto Distribution Inc. (Kanto) warrants the equipment it manufactures to be free from defects in material and workmanship for the following limited warranty period of: 5 years parts and labour

If equipment fails because of such defects and Kanto or an authorized dealer is notified within 5 years from the date of shipment with proof of original invoice, Kanto will, at its option, repair or replace the equipment, provided that the equipment has not been subjected to mechanical, electrical, or other abuse or modifications. Equipment that fails under conditions other than those covered will be repaired at the current price of parts and labor in effect at the repair. Such repairs are warranted for 90 days from the day of reshipment to the original purchaser. This warranty is in lieu of all other warranties expressed or implied, including without limitation, any implied warranty or merchantability or fitness for any particular purpose, all of which are expressly disclaimed. Customers will be responsible for obtaining a Return Authorization as well as shipping costs to return product to a Kanto location or authorized depot listed on the website. If the equipment is covered under the warranty provisions above, Kanto will repair or replace, and be responsible for return shipping to the customer. Please keep the original packaging so products will not be damaged during shipping, and we recommend you insure your shipment. If equipment fails outside the warranty provisions, customers will be quoted repair and return shipping costs prior to work being performed.

The information in the owner's manual has been carefully checked and is believed to be accurate. However, Kanto assumes no responsibility for any inaccuracies that may be contained in the manual. In no event will Kanto, be liable for direct, indirect, special, incidental, or consequential damages resulting from any defect or omission in this manual, even if advised of the possibility of such damages.

