

RV250G

Bring your TV along for the ride.

Specially designed for RVs and boats, this full motion mount features an easy-lock mechanism and adjustable rubber bumpers to prevent your TV from moving during transit. Galvanized and stainless steel parts are used to inhibit rust, while a durable powder coated finish protects against wear and tear. Along with a detachable arm assembly, the RV250G includes a secondary wall plate, giving you the freedom to easily transfer your TV between your home and vehicle. Velcro cable management straps and screw-on wall plate covers are also included to ensure a clean and organized setup.

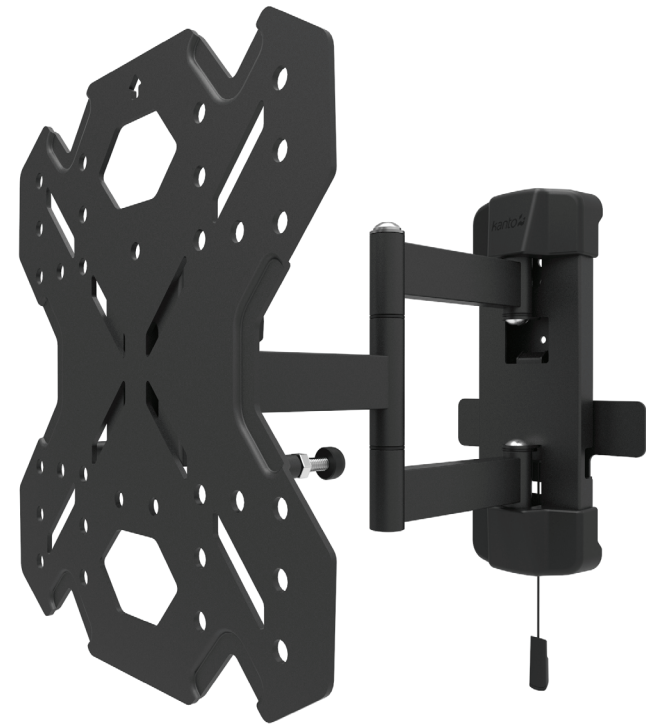

FEATURES & SPECIFICATIONS

- Fits most flat panel TVs from 26" to 42"
- Supports TVs up to 40 lb (18 kg)
- Designed for use on RVs, Boats and Decks
- Accommodates VESA sizes: 50x50, 75x75, 100x100, 100x150, 100x200, 150x100, 150x150, 200x100, 200x150, 200x200
- 60° of swivel in either direction, depending on screen size
- Sits 2.6" (6.7 cm) and extends up to 12.7" (32.2 cm) from the wall
- Includes two wall plates to easily transfer your TV between your home and vehicle
- Includes cable management straps
- Locking articulating arm with quick release pull cord secures your tv during transit
- Galvanized steel construction and stainless steel hardware allow for outdoor installation
- Five Year Manufacturer's Warranty
- Shipping box weight: 11.7 lb (5.3 kg)
- Shipping Box Dimensions: 16.6" x 12.8" x 3.1" (42.2 x 32.5 x 7.9 cm)
- Product Weight: 9.7 lb (4.4 kg)
- UPC: 800152718095

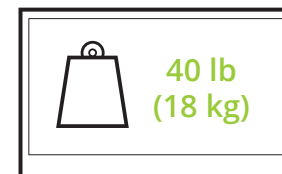
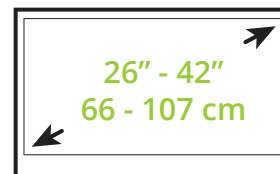

50x50
200x200
VESA
COMPLIANT

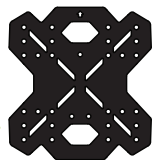

TECHNICAL ILLUSTRATIONS

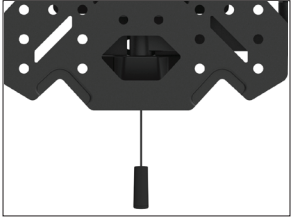

SAFE AND SECURE

The quick release latch system keeps your TV secure while your RV or boat is in transit. Adjustable rubber bumpers are also located behind the TV plate for added stability.

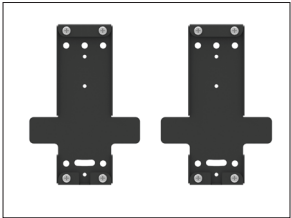

2-IN-1 FUNCTIONALITY

Two wall plates are provided so that you can enjoy your TV at home and on-the-go. Easily slide the extension arm off one wall plate and attach it to the other.

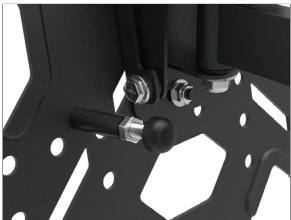

RUSTPROOF DESIGN

To protect against rust and general wear and tear, the RV250G is constructed out of galvanized steel with a durable powder coated finish, and assembled with stainless steel hardware.

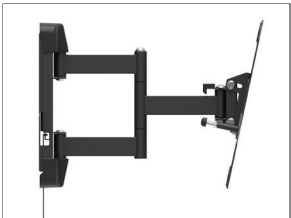

MULTIPLE VIEWING OPTIONS

Providing 12.7" of extension, the articulating arm allows you to tilt, pan and swivel your TV for optimal viewing.



CLEAN SETUP

Along with screw-on wall plate covers, the RV250G comes with Velcro straps to keep your cables organized and out-of-sight.

