

# PDX680

## Design at its finest.

Meet PDX680, the standard in full motion mounts from Kanto. Sitting a mere 2" from the wall and extending up to 24", the PDX680 is the perfect solution for versatility.

PDX680 offers 18° of tilt and a 27" wall plate to accommodate up to 24" studs. With integrated cable management and plastic caps to hide the lag bolts in the wall, the PDX680 is not only functional, but easy on the eyes too.

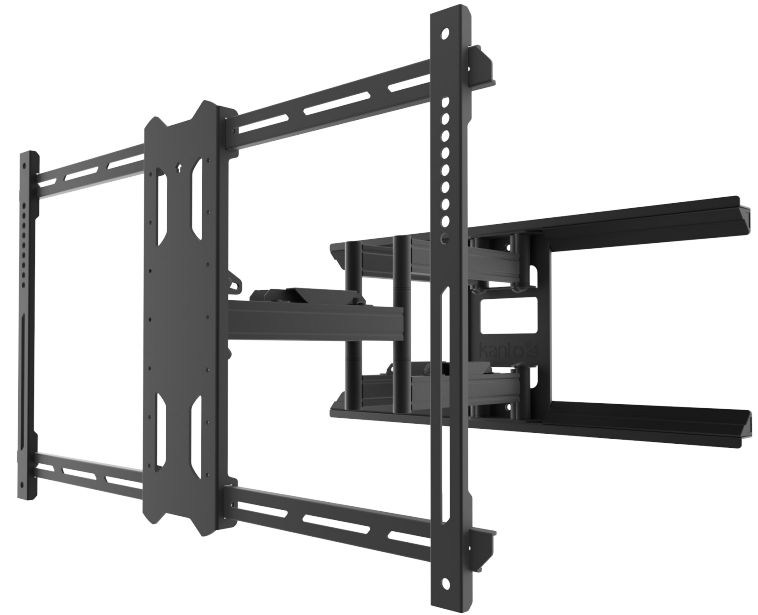

## FEATURES & SPECIFICATIONS

- Fits most TVs from 39" to 80"
- Supports TVs up to 125 lb (57 kg)
- Accommodates VESA sizes from 100x100 to 700x400
- Accessible tilt mechanism provides a +15° to -3° viewing angle
- 85° of swivel in either direction, depending on screen size
- Sits 2" (5 cm) from the wall
- Extends up to 24" (61 cm) from the wall
- Integrated cable management
- Adjustable horizontal leveling
- 27" (68.5 cm) dual stud wall plate accommodates up to 24" stud spacing
- Solid steel construction with durable powder coated finish
- Four magnetic plastic covers conceal the lag bolts after installation
- Installation manual and all mounting hardware for wood stud and concrete installation is included
- Five year warranty
- Shipping box weight: 27.6 lb (12.5 kg)
- Shipping Box Dimensions: 29.6" x 12.8" x 4.3" (75.2 x 32.5 x 11 cm)
- Product Weight: 22.3 lb (10.1 kg)
- UPC: 800152715315

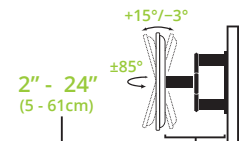
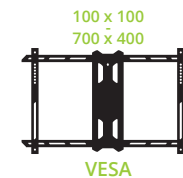
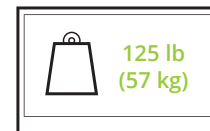
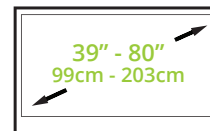

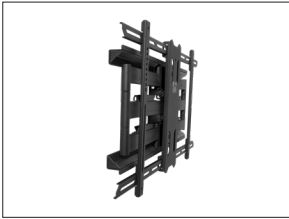

### LOW PROFILE DESIGN

The unique design of the PDX680 allows your TV to sit 2" from the wall when fully pushed in.

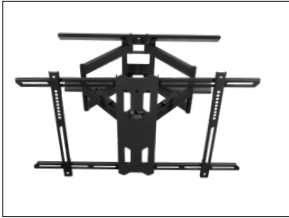

### EXTENDS UP TO 24 INCHES

With 24" of extension, the PDX680 is perfect for reaching over fireplaces, or out of alcoves and recessed locations.



### SUPPORTS 125 POUNDS

Designed with strength in mind, the PDX680's solid steel frame can hold up to 125 pounds with no concern, even at full extension.

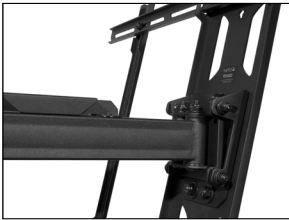

### 18 DEGREES OF TILT

PDX680 offers 18° of tilt, allowing you to find the perfect viewing angle. Once your TV is in the right position, tighten the bolts on the tilt mechanism to ensure your TV stays where you want it.

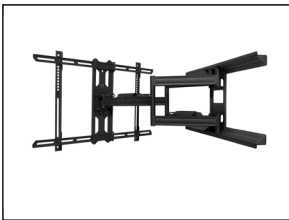

### WIDE RANGE OF SWIVEL

The articulating arms allow you to swivel your TV 85° in either direction, depending on your TV size, allowing you to achieve the perfect viewing angle.



### EVERYTHING YOU NEED

We supply you with everything except a toolbox to ensure that your installation goes smoothly. Instruction manuals are provided in English, French, and Spanish, as well as all the parts you need to mount your TV safely and securely.

## TECHNICAL ILLUSTRATIONS

