

## FULL MOTION DUAL STUD MOUNTS

# FMX3

Improve your TV viewing experience with the FMX3 full motion wall mount. Offering 28 inches of extension, the FMX3's heavy-duty articulating arms allow you to pan, swivel and tilt your TV to achieve the best view from wherever you're seated. Conveniently mount it to wood studs up to 24" apart, or use the provided anchors for concrete or brick installations. Quick to install, the FMX3 comes with a paper drill template to accurately mark your pilot holes, as well as cable management clips to ensure a clean and organized setup.

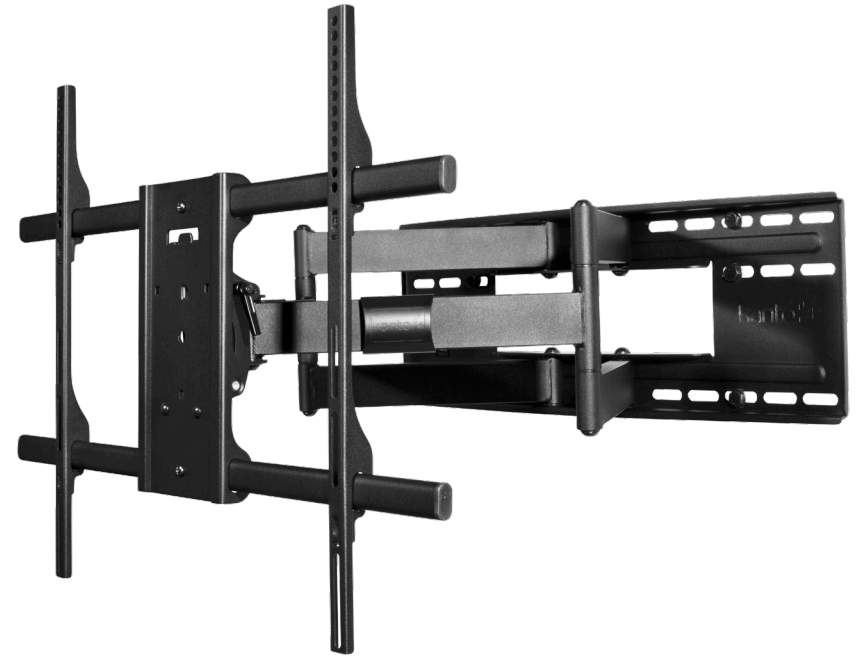

## FEATURES & SPECIFICATIONS

- Fits most flat panel TVs from 40" to 90"
- Supports TVs up to 150 lb (68 kg)
- Accommodates VESA sizes from 200x100 to 700x500
- Accessible tilt mechanism provides a +15° to -5° tilt angle
- 88° of swivel in either direction, dependent on screen size.
- Sits 4" (10 cm) from the wall
- Extends up to 28" (71 cm) from the wall
- Integrated cable management system
- Adjustable horizontal leveling
- 26.8" (68 cm) dual stud wall plate accommodates up to 24" stud spacing
- Includes paper wall template for marking pilot holes
- Installation manual and all mounting hardware for wood stud and concrete installation is included
- Five year warranty
- Shipping box weight: 33.5 lb (15.2 kg)
- Shipping box dimensions: 31.3" x 13.1" x 3.9" (79.4 cm x 33.2 x 9.8 cm)
- Product weight: 30.4 lb (13.8 kg)
- UPC: 800152015590

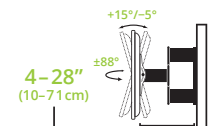
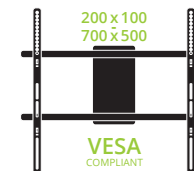
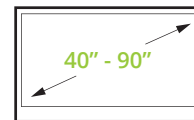

## TECHNICAL ILLUSTRATIONS

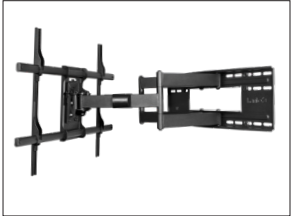

### ENHANCED VIEWING EXPERIENCE

Pull your screen 28" from the wall, tilt it +15°/-5°, and swivel it 45° to 88° left or right, depending on screen size. Adjustable horizontal leveling is also provided to ensure your TV is perfectly positioned.

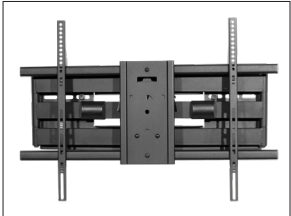

### STAY ORGANIZED AND SAVE SPACE

Increase floor space and improve the appearance of any room or office by mounting your TV with the FMX3. Removable cable management clips are also provided to route your cables neatly back to the wall.

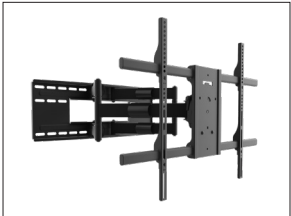

### SUPERIOR CONSTRUCTION

The FMX3's solid steel construction and heavy-duty lag bolts are designed to support up to 150 pounds, making it perfectly suited for TVs as large as 90 inches. Its long-lasting, powder-coated finish also looks great against any wall or surface.

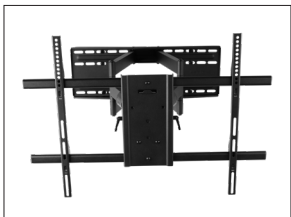

### IMPROVED SAFETY AND SECURITY

Regular TV stands are prone to tipping, increasing the likelihood of damaging your screen or injuring others. Mounting your TV with the FMX3 is the best way to ensure that it remains securely in place.



### EASY TO INSTALL

To ensure a hassle-free installation, the FMX3 includes an organized bolt pack with all of the necessary hardware for wood stud and concrete installations; a paper drill template with a convenient dust catcher to mark and drill your pilot holes; and an easy-to-follow online video to assist you every step of the way.

