

FIXED FLAT PANEL TV MOUNT

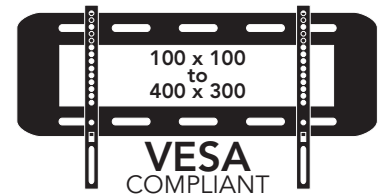
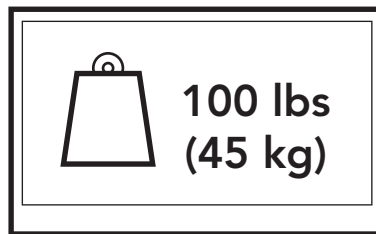
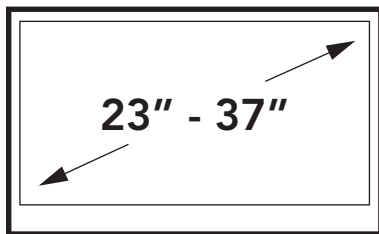

Table of Contents

Table of Contents / Introduction	2	Setup - Steps 3 to 4	6
Supplied Parts & Hardware	3	Other Kanto Products	7
Setup - Step 1	4	Warranty	8
Setup - Step 2	5		

Introduction

Thank you for choosing a Kanto AV Systems wall mount. The F2337 is designed to mount flat panel televisions weighing up to 100 lbs (45 kg) within 1" of your wall.

Read these instructions fully before installation of this mount. If you do not understand these directions, or have any doubts about the safety of the installation, please consult a qualified installation contractor to install this mount. Make sure there are no defective or missing parts. Do not use defective parts. If you are uncertain whether the part is defective call Kanto AV Systems directly at 1-888-848-2643 or support@kantoav.com. Kanto AV Systems can not be liable for property damage or injury caused by incorrect mounting, incorrect assembly, lifting or incorrect use of this product.

This product should not be mounted on steel stud walls or cinder block walls. Consult a qualified installation contractor if you are unsure about the type of wall you may have. We make every effort to ensure all necessary hardware is included. If there is hardware missing please call Kanto AV Systems directly at 1-888-848-2643 or support@kantoav.com.

See installation video online at:

www.kantoav.com/pages/video-f2337



CAUTION

The maximum loading weight is 100 lbs (45 kg). This wall mount is intended for use only within the maximum weight restrictions indicated. Use with products heavier than the maximum weights indicated may result in instability causing possible injury. Recommended TV Size: 23 inch to 37 inch.



CAUTION

The wall you plan to affix the Kanto mount to must be able to support more than 5 times the weight of the television and the wall mount combined. Do not use this product for any purpose other than to mount a flat panel TV on a vertical surface as outlined in this manual. Improper installation may cause damage to your TV or serious injury. This product should not be mounted to steel stud walls, cinder block or old concrete walls. Consult a qualified installation contractor if you are unsure about the type of wall you may have.

Supplied Parts and Hardware

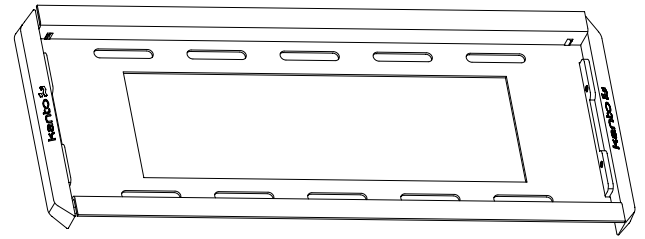

Wall Plate



x4

A: M4 x 15mm
Screw

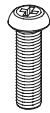

x4

B: M4 x 25mm
Screw



x4

C: M5 x 15mm
Screw

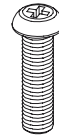

x4

D: M5 x 25mm
Screw

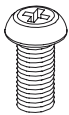

x4

E: M6 x 15mm
Screw

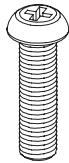

x4

F: M6 x 25mm
Screw

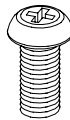

x4

G: M8 x 15mm
Screw

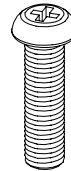

x4

H: M8 x 25mm
Screw

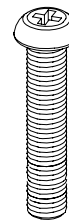

x4

I: M8 x 35mm
Screw

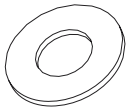

x4

J: Washer

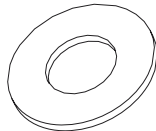

x4

K: Lag Bolt Washer

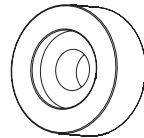

x4

L: Plastic Spacer

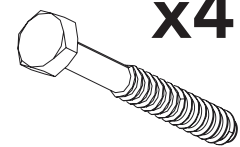

x4

M: Lag Bolt

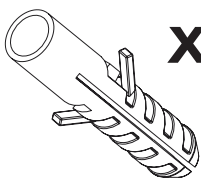

x4

N: Concrete Anchor

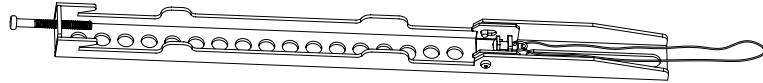

x2

R: Quick-Lock
TV Bracket

Required Tools

- 3/16" wood drill bit
- 7/16" masonry bit (for concrete installs)
- Socket set
- Phillips screwdriver
- hammer (for concrete installs)
- carpenter's level
- stud finder

Step 1: Attach TV Brackets

There are a wide variety of TVs available offering an assortment of screw sizes. We provide a selection of mounting screws to fit most TVs. If you have any concerns about this mounting hardware or installation call us direct at 1-888-848-2643 or email at support@kantoav.com.

Step 1.1 Select the correct size of bolt.

Kanto provides 4 bolt diameters (Metric sizes M4, M5, M6 and M8) in various lengths.

Part items: A, B, C, D, E, F, G, H, or I

Select the correct diameter screw and hand screw into the back of the TV to determine the correct length. Use the longest available bolt without reaching the bottom of the TV threads.

If your TV has a curved back, you can use the spacers (L).

Step 1.2 Attach TV bracket arms to the back of the TV

Now that you have selected the correct bolt length, it's time to attach the arms to the TV, as shown in Diagram A.

Use the washer (J) for bolts A-F (sizes M4, M5 and M6). The washer will work for all three screw sizes.

Please note: The washer is not required for M8 size bolts (G, H & I).

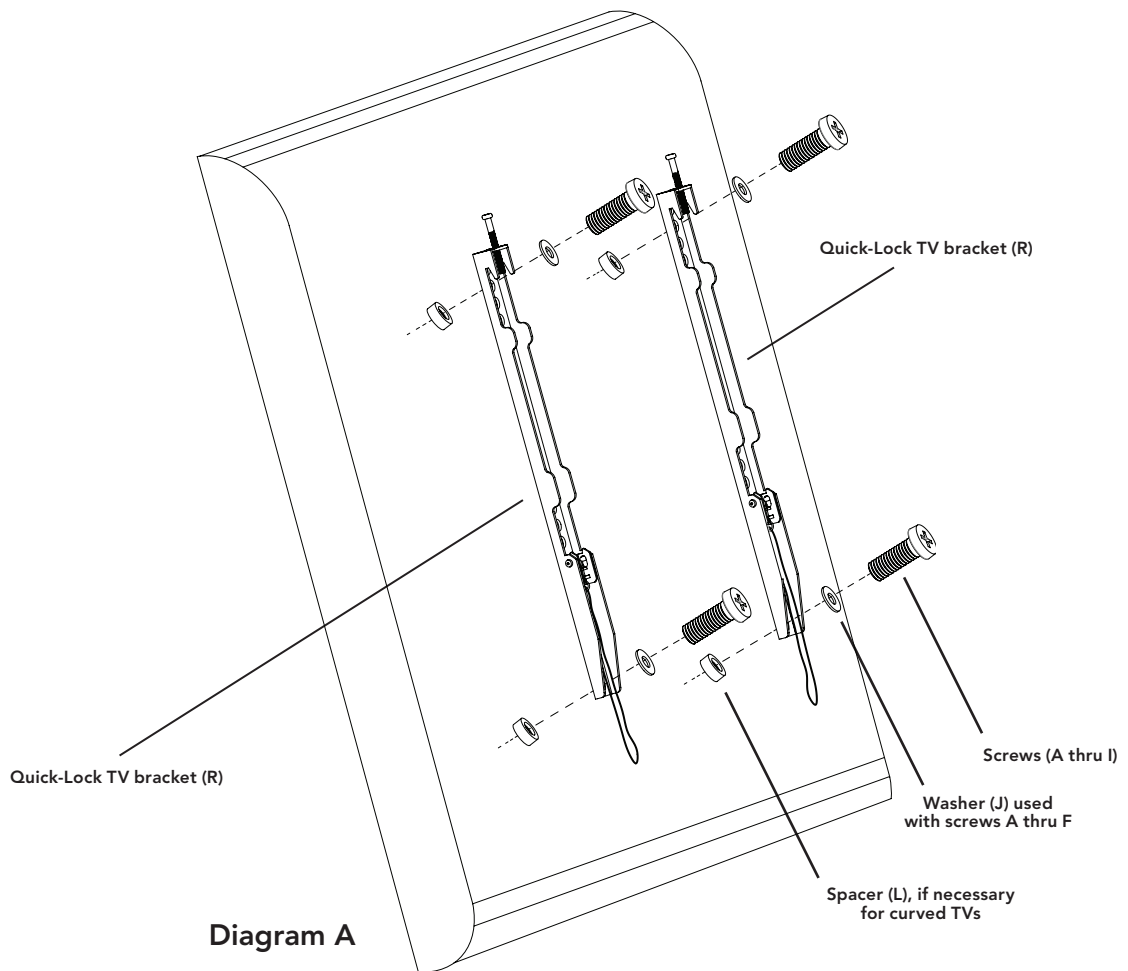

WARNING

Never over-tighten a screw into the back of your flat panel TV. Do not lay the TV face down on its glass front. Use a wall or a TV stand.

Step 2: Mount Wall Plate

Wood Stud Wall

The Wall Plate must be mounted to two wood studs. Use a stud sensor to locate the two studs, clearly marking the outer edges of the studs (see Diagram B). Use a long level to ensure the two holes are level at the desired height.

Pre-drill two upper holes in the center of your studs, and attach the Wall Plate to the wall using 2 Lag Bolts (**M**) and Lag Bolt Washers (**K**) (see Diagram B). Do not over-tighten lag bolts (**M**). Make sure the Wall Plate is flat against the wall surface. Using the Wall Plate as template, pre-drill the bottom 2 holes, and secure using 2 Lag Bolts (**M**) and 2 Lag Bolt Washers (**K**), taking care not to over-tighten.

Wood

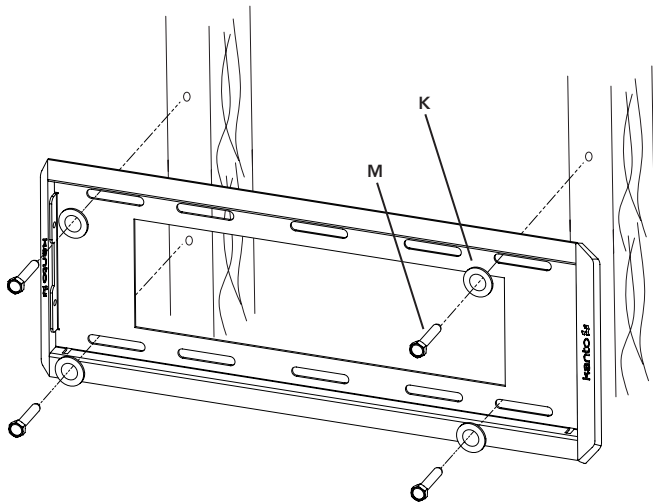
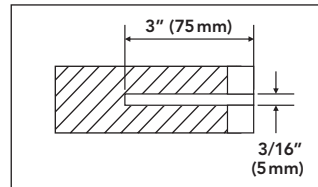

Diagram B



CAUTION

Make sure the supporting surface will support the load limits outlined in the Caution at bottom of page two. Tighten Lag Bolts until the Wall Plate is snug flat against the wall. Do not over tighten Lag Bolts (**M**). Each Lag Bolt must be located in the center of a wood stud.

Brick or Concrete Wall

Using the Wall Plate as a template, mark four holes toward the outer edge of the Wall Plate at your desired height (see Diagram C). Adjust the Wall Plate position to be clear of mortar joints, keeping in mind that the mount provides minor horizontal shift along the length of the Wall Plate. Use a long level to ensure the four holes are level and at the desired height.

Pre-drill four holes, and insert a Concrete Anchor (**N**) into each of the holes flush with the concrete wall surface and not flush with the surface covering, such as drywall.

Attach the Wall Plate using 4 Lag Bolts (**M**) and Lag Bolt Washers (**K**) (see Diagram C). Make sure the Wall Plate is flat against the wall surface. Do not over-tighten Lag Bolts (**M**).

Concrete

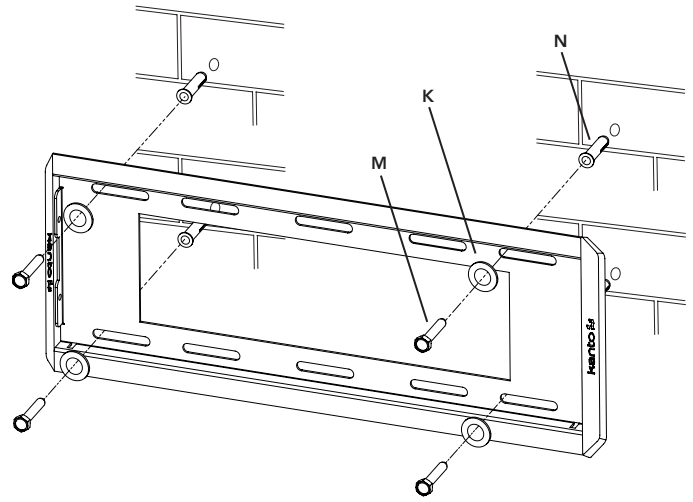
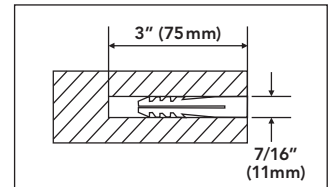

Diagram C



CAUTION

Make sure the concrete or brick wall is at least 3.5" thick. Make sure the anchor is seated completely flush with the concrete surface even if there is another layer of material, such as drywall. If drywall is over 5/8" thick custom lag bolts must be used. Concrete must be a minimum of 2000psi in density.



CAUTION

Read this section carefully prior to install.

Step 3: Attach TV to Wall Plate

With the TV brackets firmly secured to the TV, use two people to lift the TV into position and hook the TV brackets onto the wall plate, as shown in Diagram D.

The two spring loaded Quick-Lock brackets will snap into place as you lower the bottom of the TV onto the plate.

For minor level adjustment, you can adjust the two top screws using a Phillips screwdriver to ensure the TV hangs level, as shown in Diagram E. If you need to release pressure on the screws, pull down slightly on the Quick Release cords as shown in Diagram F.

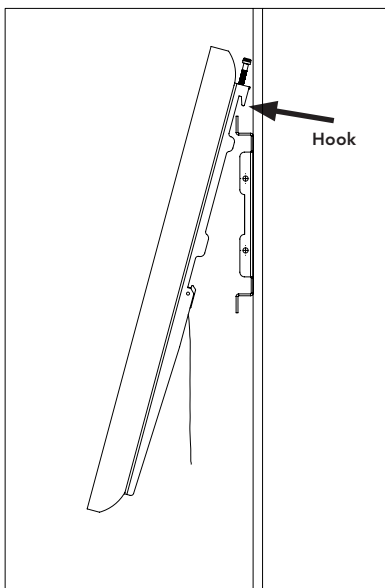

Diagram D

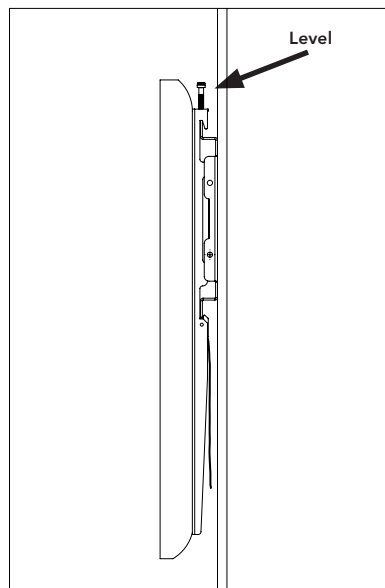

Diagram E

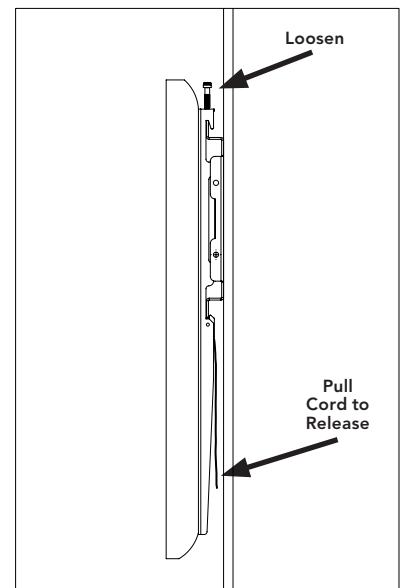

Diagram F

Step 4: Release the TV

Because the TV sits so close to your wall, the Quick-Lock TV brackets are equipped with quick release cords. Loosen the top levelling screws slightly to release tension, then simply pull to release both Quick-Locks (as shown in Diagram F), and pull the bottom of the TV away from the wall. Then, using two people, lift the TV up and away from the wall plate.



WARNING

Use two people to lift and position the TV onto the Wall Plate.



Check out more great products from Kanto!

Kanto YARO Speaker System

- Our stunning new audio system designed for Apple TV
- Utilizing audio technology by Bang & Olufsen ICEpower
- 100 watts of pure clean sound
- Optional 200 watt sub-woofer
- Visit kantospeakers.com for more!

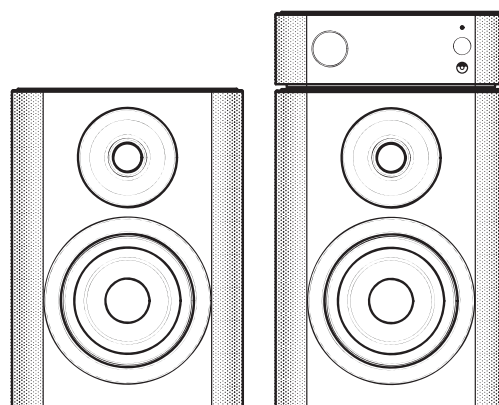

Kanto Infinity Series Cables

- 3D and 1080p HD Full Colour Capabilities
- 24 kt gold plated contacts
- Metal head connectors with flex relief and grip
- HDMI Ethernet Channel



For more TV and desktop mounts, along with our other products, please visit kantoav.com.

“LIKE” Kanto on Facebook to receive upcoming news and special product offers.

Warranty

Limited Warranty To Original Purchaser

Kanto AV Systems (Kanto) warrants the equipment it manufactures to be free from defects in material and workmanship for the following limited warranty period of:

24 months parts and labour

If equipment fails because of such defects and Kanto or an authorized dealer is notified within 24 months from the date of shipment with proof of original invoice. Kanto will, at its option, repair or replace the equipment, provided that the equipment has not been subjected to mechanical, electrical, or other abuse or modifications. Equipment that fails under conditions other than those covered will be repaired at the current price of parts and labor in effect at the repair. Such repairs are warranted for 90 days from the day of reshipment to the original purchaser. This warranty is in lieu of all other warranties expressed or implied, including without limitation, any implied warranty or merchantability or fitness for any particular purpose, all of which are expressly disclaimed.

The information in the owner's manual has been carefully checked and is believed to be accurate. However, Kanto assumes no responsibility for any inaccuracies that may be contained in the manual. In no event will Kanto, be liable for direct, indirect, special, incidental, or consequential damages resulting from any defect or omission in this manual, even if advised of the possibility of such damages.

Rev 12-05